

SPO

SPO SERIES SINGLE POINT LOAD CELLS



Load cells for off center loads, suitable for example to build CE-M approved scales with a single load cell with maximum dimensions of 300x300 mm.

CAPACITIES (kg): 3, 5, 10, 15, 20, 30.

Aluminium alloy. IP67 protection. C3 precision class.

Working in cooperation with:

VAHY ROBIN S.R.O.

U SOKOLOVNY 115 - 66434 - MORAVSKE KNINICE
Tel. 00420-777433576
vahyrobin@seznam.cz

The best solution
for advanced industrial
applications

MAIN FEATURES

- C3 PRECISION CLASS
- OFF CENTER LOAD COMPENSATED
- ALUMINIUM ALLOY CONSTRUCTION
- IP67 PROTECTION
- MAX. CAPACITIES FROM 3 TO 30 kg
- FOR PLATFORMS WITH DIMENSIONS UP TO 300 X 300 mm
- SHIELDED CONNECTION CABLE
- OIML AND TEST CERTIFICATES AVAILABLE UPON REQUEST

TECHNICAL FEATURES

- Minimum load cell verification interval: $V_{min} = E_{Max}/15.000$
- Maximum number of verification intervals: $n_{LC} = 3000$
- Full Scale Output: $2mV/V \pm 10\%$
- Temperature effect on zero: $0,01\% FS/10K$
- Temperature effect on full scale output: $0,001\%FS /10K$
- Compensated Temperature Range: $-10^{\circ}C/+40^{\circ}C$
- Operating Temperature Range: $-10^{\circ}C/+50^{\circ}C$
- Creep error after 30 minutes: $0,01\% F.S$
- Maximum tolerated excitation voltage: 15 VDC
- Input Resistance: 300..500 Ohm
- Output Resistance: 300..500 Ohm
- Insulation Resistance: $>2000 MOhm$
- Safe Overload: 150% F.S.
- Ultimate Overload: 300% F.S.
- 4-wire shielded cable, 40cm long, 3,2mm diameter

ATEX Version

- The CCATEX certificate makes the load cell suitable for use in hazardous areas with protection methods according to:
ATEX II 1G Ex ia IIC T6 (Ta $-20 \div +40^{\circ}C$) TX (Ta $-20 \div +65^{\circ}C$) Ga
ATEX II 1D Ex ta IIIC TX $^{\circ}C$ (Ta $-20 \div +40^{\circ}C$) TX $^{\circ}C$ (Ta $-20 \div +65^{\circ}C$) Da IP65.
The certificate includes the manual and the ATEX CE conformity declaration (available in EN, DE, FR, and IT).
- **IMPORTANT:** the certificate refers to the single load cell. For systems with more load cells, it is necessary to order one certificate for each load cell.

DETAIL 1

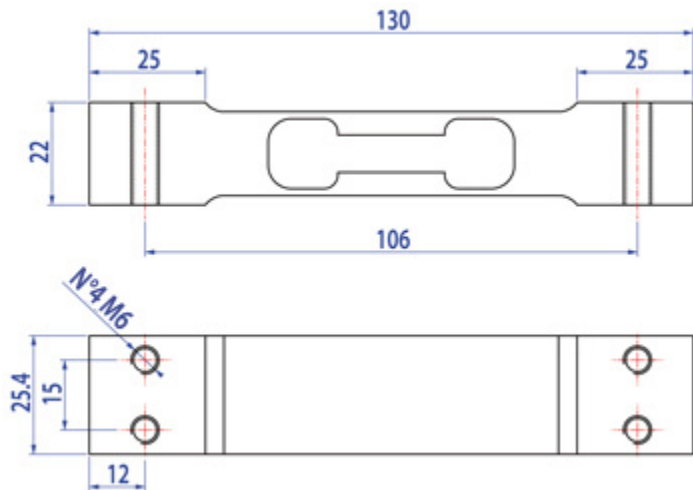







Dimensions in mm

Wiring Code	
<i>Color</i>	<i>Function</i>
YELLOW	SHIELD
WHITE	OUTPUT +
BLUE	INPUT +
RED	OUTPUT -
BLA	INPUT -

VERSIONS

Available models

Code	Max (kg)	Platform l x w Max (mm)	Masterpack 4 pcs
SPO3 	3	150x150	SPO3C
SPO5 	5	300x300	SPO5C
SPO10 	10	300x300	SPO10C
SPO15 	15	300x300	SPO15C
SPO20 	20	300x300	SPO20C
SPO30 	30	300x300	SPO30C



www.diniargeo.com



“YOUR WORLDWIDE PARTNER FOR WEIGHING”

DINI ARGEO
FRANCE sarl
Nogent-sur-Marne

DINI ARGEO
GMBH
Sinsheim - Germany

DINI ARGEO
UK Ltd
Taunton - United Kingdom

DINI ARGEO WEIGHING
INSTRUMENTS Ltd
Shanghai - China

DINI ARGEO
WEIGHBRIDGES
Calto (RO) – Italy



HEAD OFFICE
Via Della Fisica, 20
41042 Spezzano di Fiorano Modena - Italy



VAHY ROBIN S.R.O.

U SOKOLOVNY 115 - 66434 - MORAVSKE KNINICE

Tel. 00420-777433576

vahyrobin@seznam.cz

SALES AND TECHNICAL ASSISTANCE SERVICE