

SPG

SPG SERIES SINGLE POINT LOAD CELLS, C3 CLASS



Load cells for off center loads, suitable for example to build CE-M approved scales with a single load cell; maximum platform dimensions of 600x600 mm.

CAPACITIES (kg): 10, 15, 20, 30, 50, 100, 200.

Aluminium alloy. IP67 protection. C3 precision class.

Working in cooperation with:

VAHY ROBIN S.R.O.

U SOKOLOVNY 115 - 66434 - MORAVSKE KNINICE
Tel. 00420-777433576
vahyrobin@seznam.cz

The best solution
for advanced industrial
applications

MAIN FEATURES

- C3 PRECISION CLASS
- OFF CENTER LOAD COMPENSATED
- ALUMINIUM ALLOY CONSTRUCTION
- IP67 PROTECTION
- MAX. CAPACITIES FROM 10 TO 200 kg
- FOR PLATFORMS WITH DIMENSIONS UP TO 600 X 600 mm
- SHIELDED CONNECTION CABLE
- OIML CERTIFICATE AVAILABLE UPON REQUEST
- TEST CERTIFICATE AVAILABLE UPON REQUEST

TECHNICAL FEATURES

- Minimum load cell verification interval: $V_{min} = E_{Max} / 15.000$
- Maximum number of verification intervals: $n_{LC} = 3000$
- Sensitivity: $2mV/V \pm 10\%$
- Combined error: 0,03% of Full Span (F.S.)
- Temperature effect on zero: 0,01% FS/10K
- Temperature effect on Full Span: 0,001% FS/10K
- Compensated Temperature Range: $-10^{\circ}C/+40^{\circ}C$
- Operating Temperature Range: $-10^{\circ}C/+50^{\circ}C$
- Creep at nominal load in 30 minutes: 0,01% F.S.
- Maximum excitation voltage without damage: 15 Vdc
- Input Resistance: 300..500 Ohm
- Output Resistance: 300..500 Ohm
- Zero Balance: $0 \pm 0,1\%$ F.S.
- Insulation Resistance: >2000 MOhm
- Mechanical limit load in service: 150% F.S.
- Destructive load: 300% F.S.
- Deflection at nominal load $<0,3mm$
- 6-wire shielded cable, 3m long, 4,7mm diameter

ATEX Version

- The CCATEX certificate makes the load cell suitable for use in hazardous areas with protection methods according to:
ATEX II 1G Ex ia IIC T6 (Ta $-20^{\circ}C/+40^{\circ}C$) TX (Ta $-20^{\circ}C/+65^{\circ}C$) Ga
ATEX II 1D Ex ta IIIC TX $^{\circ}C$ (Ta $-20^{\circ}C/+40^{\circ}C$) TX $^{\circ}C$ (Ta $-20^{\circ}C/+65^{\circ}C$) Da IP65.
The certificate includes the manual and the ATEX CE conformity declaration (available in EN, DE, FR, and IT).
- **IMPORTANT:** the certificate refers to the single load cell. For systems with more load cells, it is necessary to order one certificate for each load cell.

DETAIL 1

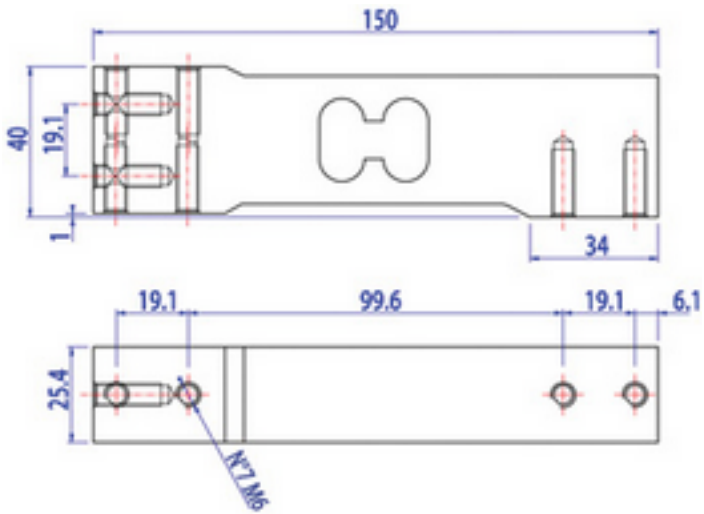







Dimensions (mm)

Wiring Code	
<i>Colour</i>	<i>Function</i>
YELLOW	SHIELD
WHITE	OUTPUT +
GREEN	SENSE +
BLUE	INPUT +
RED	OUTPUT -
GREY	SENSE -
BLACK	INPUT -

VERSIONS

Available models

Code	Max (kg)	Platform l x w Max (mm)	Masterpack 4 pcs
SPG10 	10	300x300	SPG10C
SPG15 	15	400x400	SPG15C
SPG20 	20	450x450	SPG20C
SPG30 	30	450x450	SPG30C
SPG50 	50	600x600	SPG50C
SPG100 	100	600x600	SPG100C
SPG200 	200	600x600	SPG200C



www.diniargeo.com



“YOUR WORLDWIDE PARTNER FOR WEIGHING,”

DINI ARGEO
FRANCE sarl
Nogent-sur-Marne

DINI ARGEO
GMBH
Sinsheim - Germany

DINI ARGEO
UK Ltd
Taunton - United Kingdom

DINI ARGEO WEIGHING
INSTRUMENTS Ltd
Shanghai - China

DINI ARGEO
WEIGHBRIDGES
Calto (RO) - Italy



HEAD OFFICE
Via Della Fisica, 20
41042 Spezzano di Fiorano - Modena - Italy



VAHY ROBIN S.R.O.

U SOKOLOVNY 115 - 66434 - MORAVSKE KNINICE

Tel. 00420-777433576

vahyrobin@seznam.cz

SALES AND TECHNICAL ASSISTANCE SERVICE